

CREATE  
YOUR STYLE with  
CRYSTALLIZED™  
-Swarovski Elements

WIN THE PUPPY LOVE  
OF POOCHES  
EVERYWHERE





YOUR FOUR-LEGGED SWEETHEART WILL  
FALL HEAD-OVER-PAWS



# DARLING COAT



CRYSTALLIZED™ – Swarovski Elements

Article	Product Group	Article No.
	Flat Backs No Hotfix	2028
	Crystal Buttons	3017
	Crystal Pearls	5810
	Beads	5301
	Beads	5742



## GLAMOUR SWEETNESS

If you are just as passionate about your pet as you are about handicrafts, take heart! Thanks to CREATE YOUR STYLE, you can now devote your creative energy to crafting eye-catchers for that special canine in your life. Your four-legged sweetheart

will fall head-over-paws for this crocheted jacket studded with heart-shaped beads and capped with a cuddly trimming of feather boa. This eye-catcher for dogs of all sizes looks particularly fetching on smaller breeds.

# COLLAR DECORATION

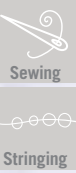

CRYSTALLIZED™ – Swarovski Elements

Article	Product Group	Article No.
	Beads	5301
	Beads	5523
	Crystal Pearls	5810



# ROYALTY ATTRACTION DECORATION

Whether big or small, mix or purebred, your dog will finally have its day with this ultra-stylish collar-enhancer. Just slip this textile sleeve over any ordinary collar to create a chic necklace whose sparkling-

crystal and shiny pearl embroidery are sure to put a royal bounce in your best friend's step – and win the puppy love of pooches everywhere.



# BANDANA

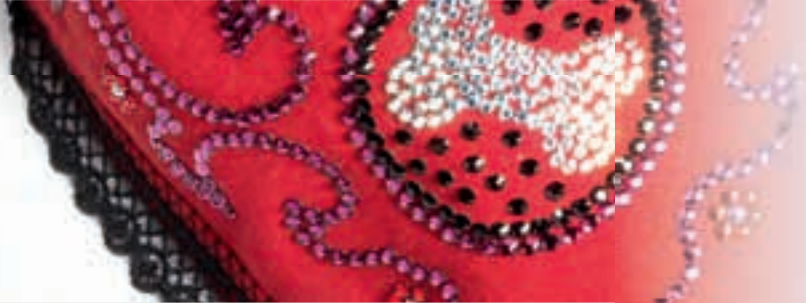

CRYSTALLIZED™ – Swarovski Elements

Article	Product Group	Article No.
	Flat Backs No Hotfix	2028



# LIFESTYLE STREETWEAR

Lifestyle aficionados everywhere will be hot-to-trot for this debonair neckpiece! Sported atop the collar of your It-dog, this streetwear-style bandana with just the right share of sparkle will bring out the

bandito in your pup – and rob you of all resistance to your little celebrity’s infinite charms.

# COLLAR BADGES



CRYSTALLIZED™ – Swarovski Elements

Article	Product Group	Article No.
	Flat Backs No Hotfix	2028



## SPARKLE COUTURE FLEXIBILITY

This fun and functional fashion accessory is as easy to create as to adore. The elastic loop on the back allows proud pet-owners to attach up to three crystal-dotted badges, making this

easy-to-clean couture conversation piece a fancy addition to any canine's collar.



# SIR DOGGY'S DINNER SET

CRYSTALLIZED™ – Swarovski Elements

Article	Product Group	Article No.
	Flat Backs No Hotfix	2028

Instruction enclosed



# EXCLUSIVENESS STYLE NOBILITY

Why give a dog a bone when you can give him a bowl fit for kings and queens? Enthroned on fine wood with fancy chequered edges, this classic culinary accessory lets four-legged-aristocrats dine in

royal style, with the dignity they deserve.  
A noble addition to any dog-lover's kitchen!

# SIR DOGGY'S DINNER SET

## CRYSTALLIZED™ – Swarovski Elements

## Supplies & Tools

Article	Product Group	Article No.	Amount	Size	Colour	Colour Code
	Flat Backs No Hot Fix	2028	18	SS5	Jet	280
	Flat Backs No Hot Fix	2028	5	SS6	Jet	280
	Flat Backs No Hot Fix	2028	39	SS10	Jet	280
	Flat Backs No Hot Fix	2028	1310	SS12	Crystal Golden Shadow F	001 GSHA
	Flat Backs No Hot Fix	2028	128	SS12	Jet	280
	Flat Backs No Hot Fix	2028	128	SS12	Black Diamond F	215
	Flat Backs No Hot Fix	2028	66	SS12	Light Siam F	227
	Flat Backs No Hot Fix	2028	658	SS12	Padparadscha F	542
	Flat Backs No Hot Fix	2028	390	SS12	Sand Opal F	287
	Flat Backs No Hot Fix	2028	132	SS12	Siam F	208
	Flat Backs No Hot Fix	2028	32	SS12	White Opal F	234
	Flat Backs No Hot Fix	2028	844	SS12	Mocca F	286

### Supplies

dog bowl h 5,5, d 15, d 18cm  
wooden board 44x28x1,4cm

### Tools

cutter  
eraser  
glue  
ruler  
tooth pick  
transparent foil (sticky on one side)  
tweezers

## STEP 1

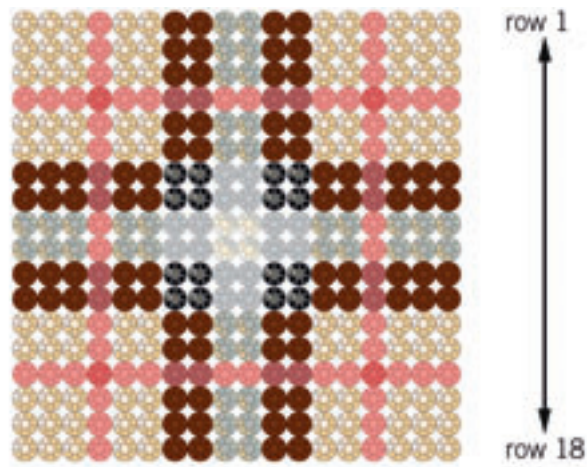

scale 1:2

STEP 2



STEP 3

repeat steps 1 & 2:



STEP 4

repeat steps 1-2 rows 2-18:

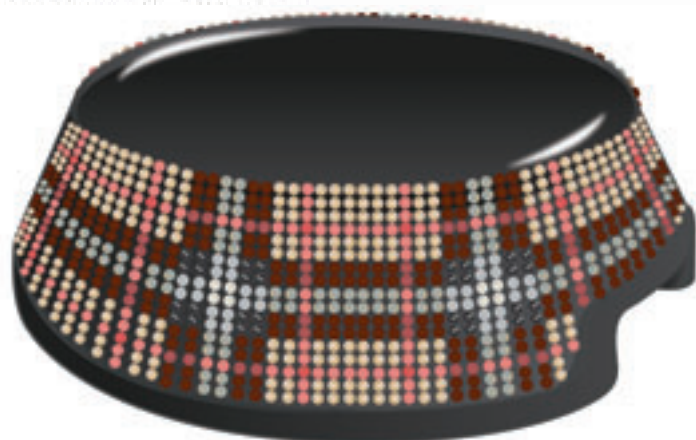



STEP 5

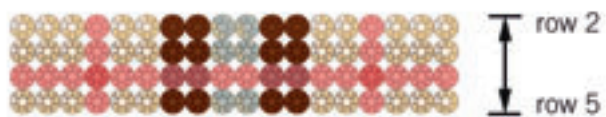

scale 1:1

repeat steps 1 & 2:

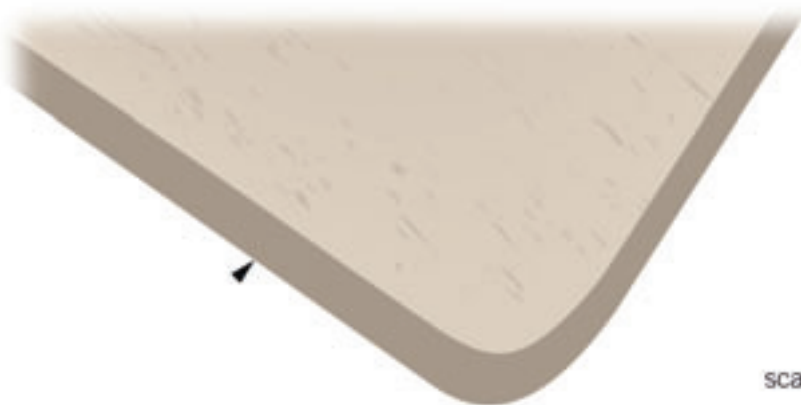

scale 1:2



STEP 6

repeat step 5:



STEP 7

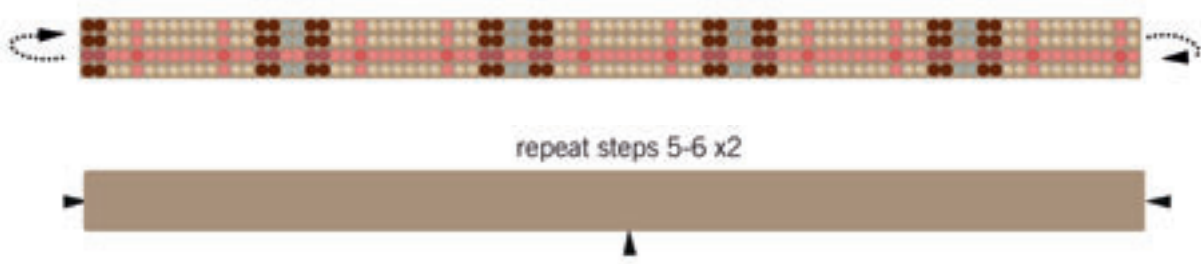

STEP 8

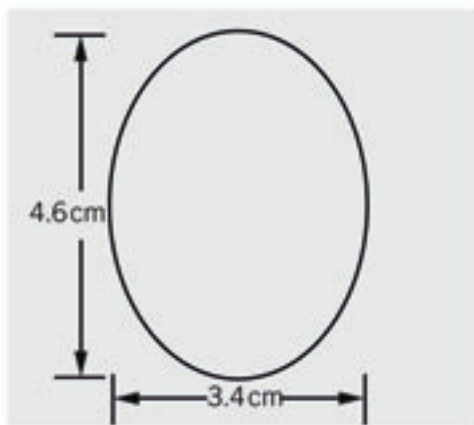

STEP 9

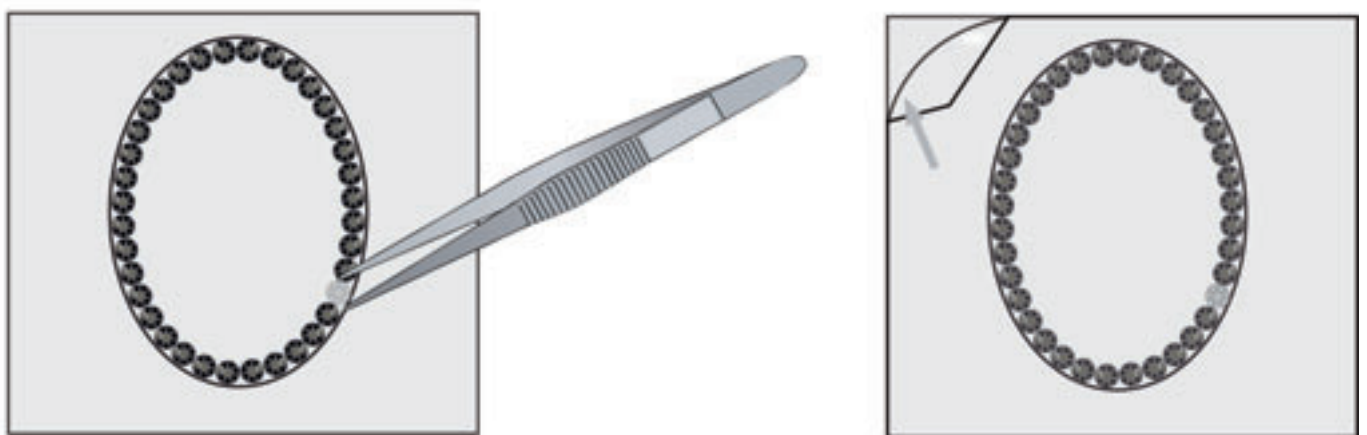

STEP 10

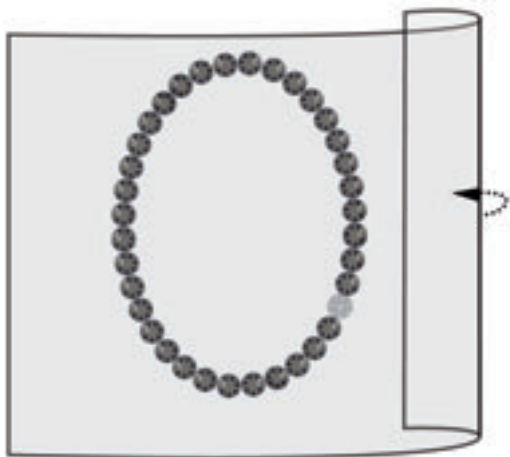

STEP 11

repeat step 9:



STEP 12

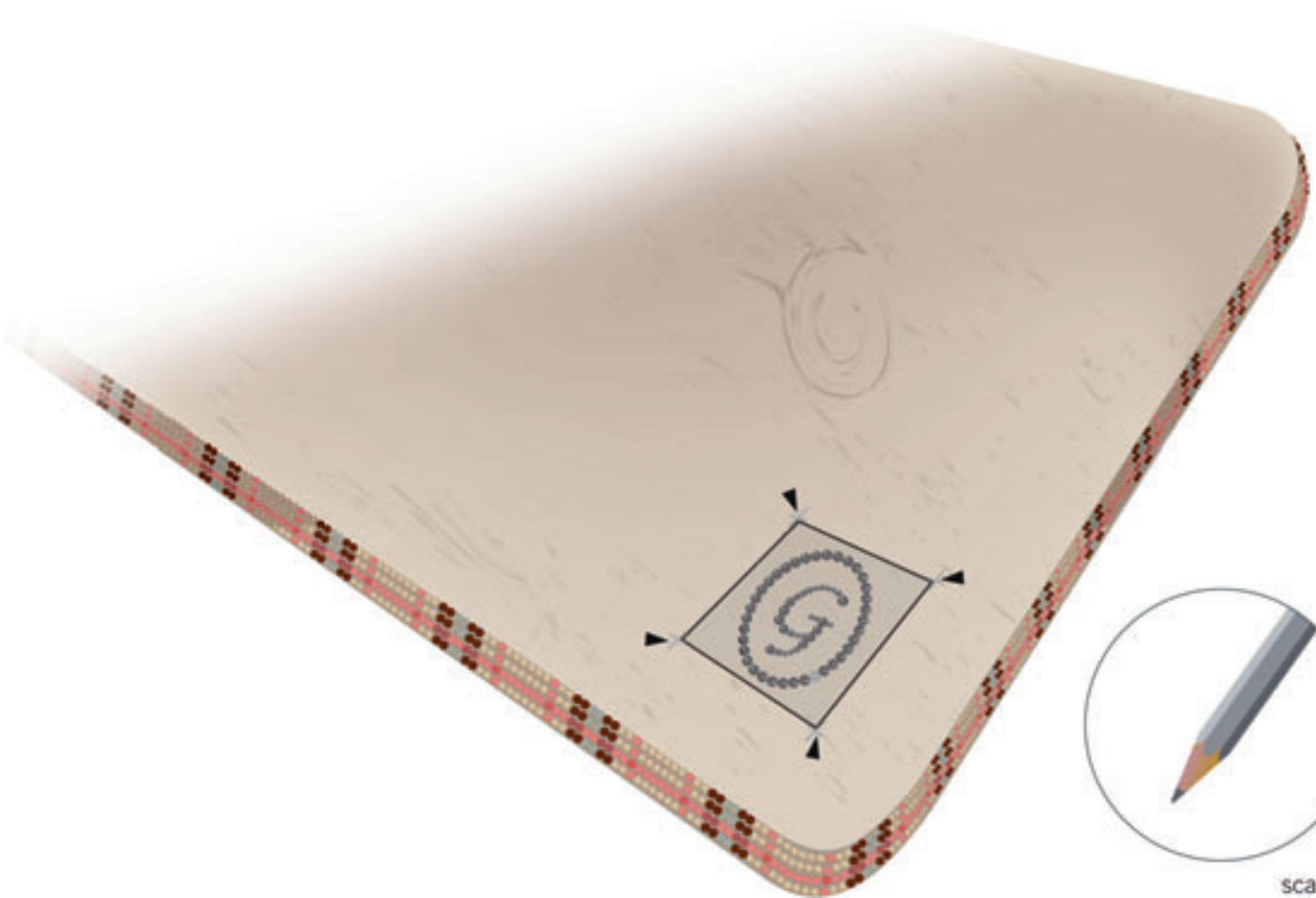

scale 1:2

STEP 13

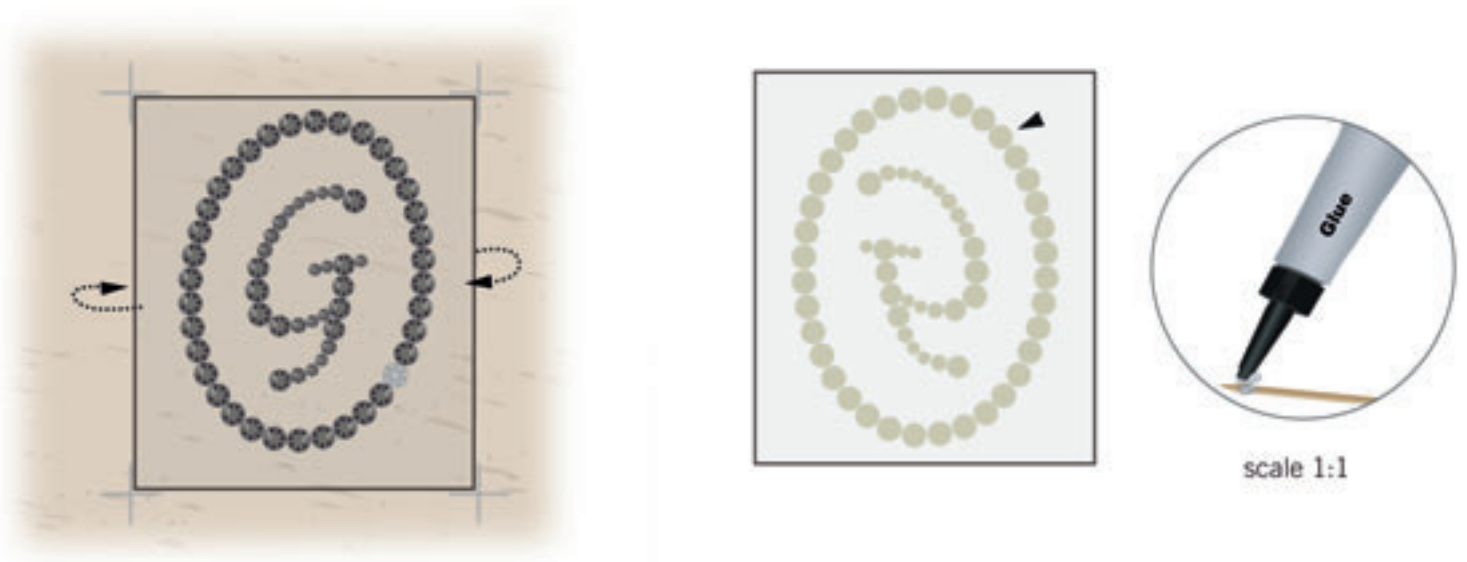

STEP 14



STEP 15

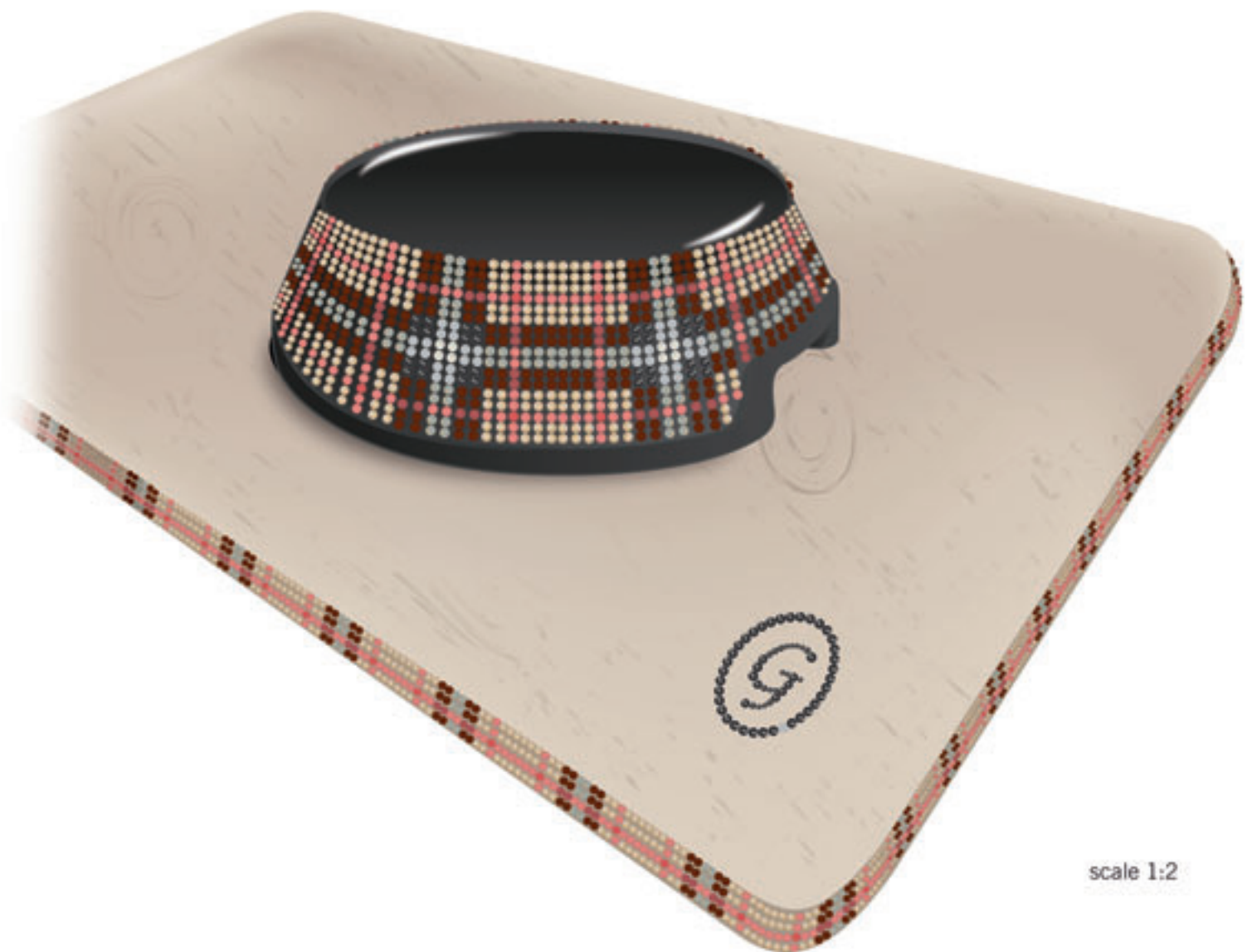

scale 1:2