

CREATE  
YOUR STYLE with  
CRYSTALLIZED™  
-Swarovski Elements

# WINDMILL

## STARS & STRIPES





# WINDMILL STARS & STRIPES



CRYSTALLIZED™ – Swarovski Elements

Supplies & Tools

Article	Product Group	Article No.	Amount	Size	Colour	Colour Code
	Beads	5040	2 pcs.	8 mm	Crystal	001
	Crystal-it	75000	25 sheets	2.3 mm	Crystal	001

- Supplies**
- 1 eraser
  - 2 pins silver
  - 50 cm wood stick Ø10 mm
  - 1 sheet paper A4 white
  - 21x21 mm cardboard blue

- Tools**
- hammer,
  - punching pliers,
  - scissors,
  - tweezers,
  - cutter,
  - ruler,
  - pencil,
  - sticky tape,
  - glue

## STEP 1

Photocopy increase by 50%:

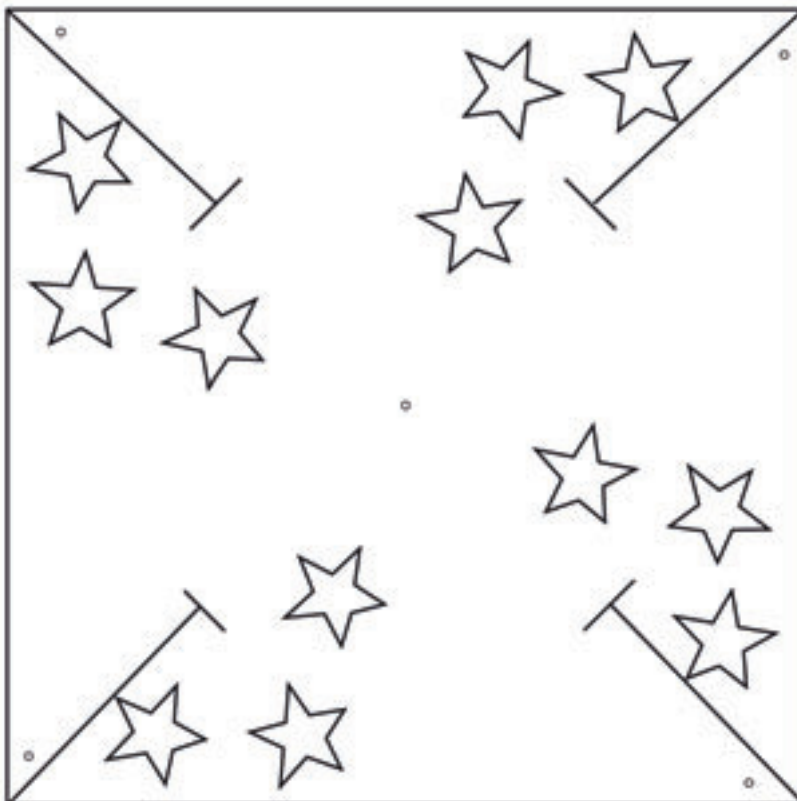

scale 1 : 2

STEP 2

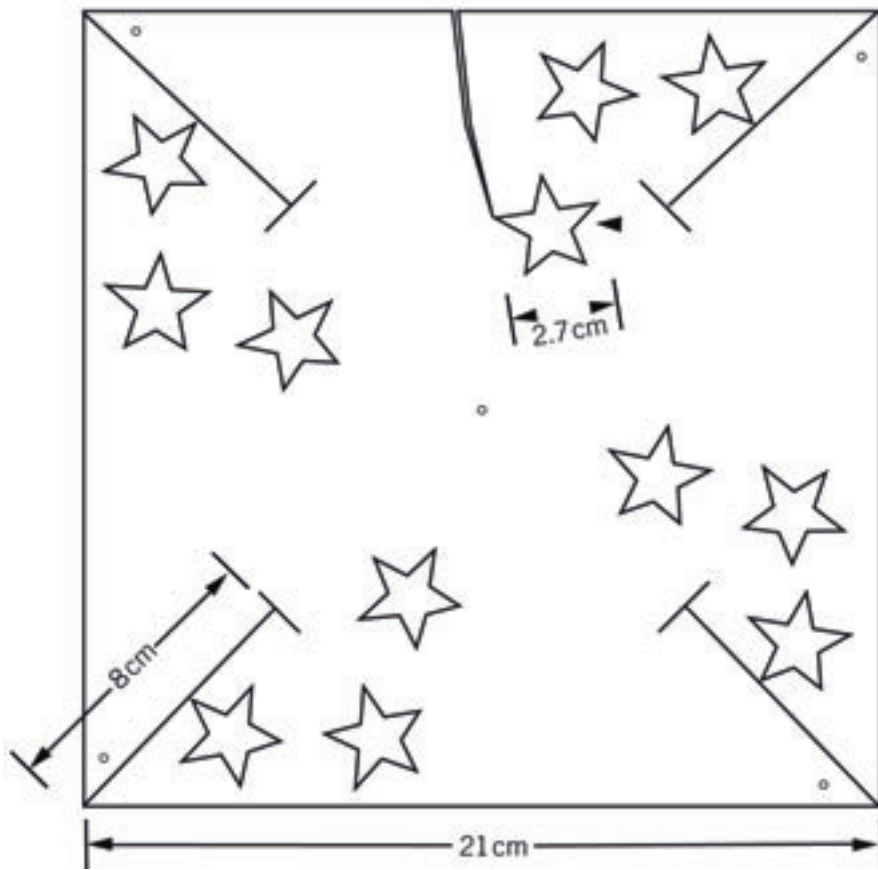

STEP 3

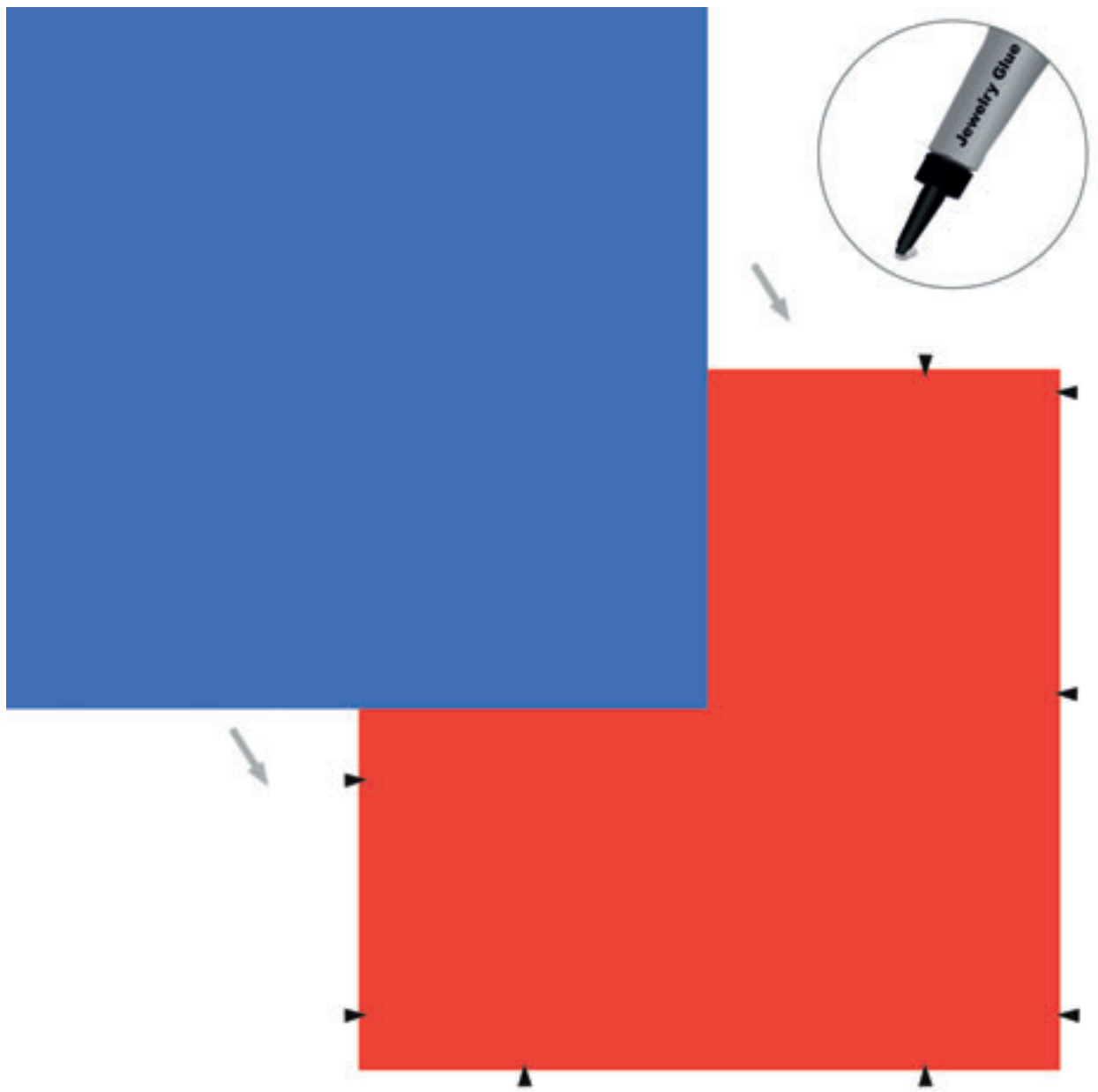

STEP 4

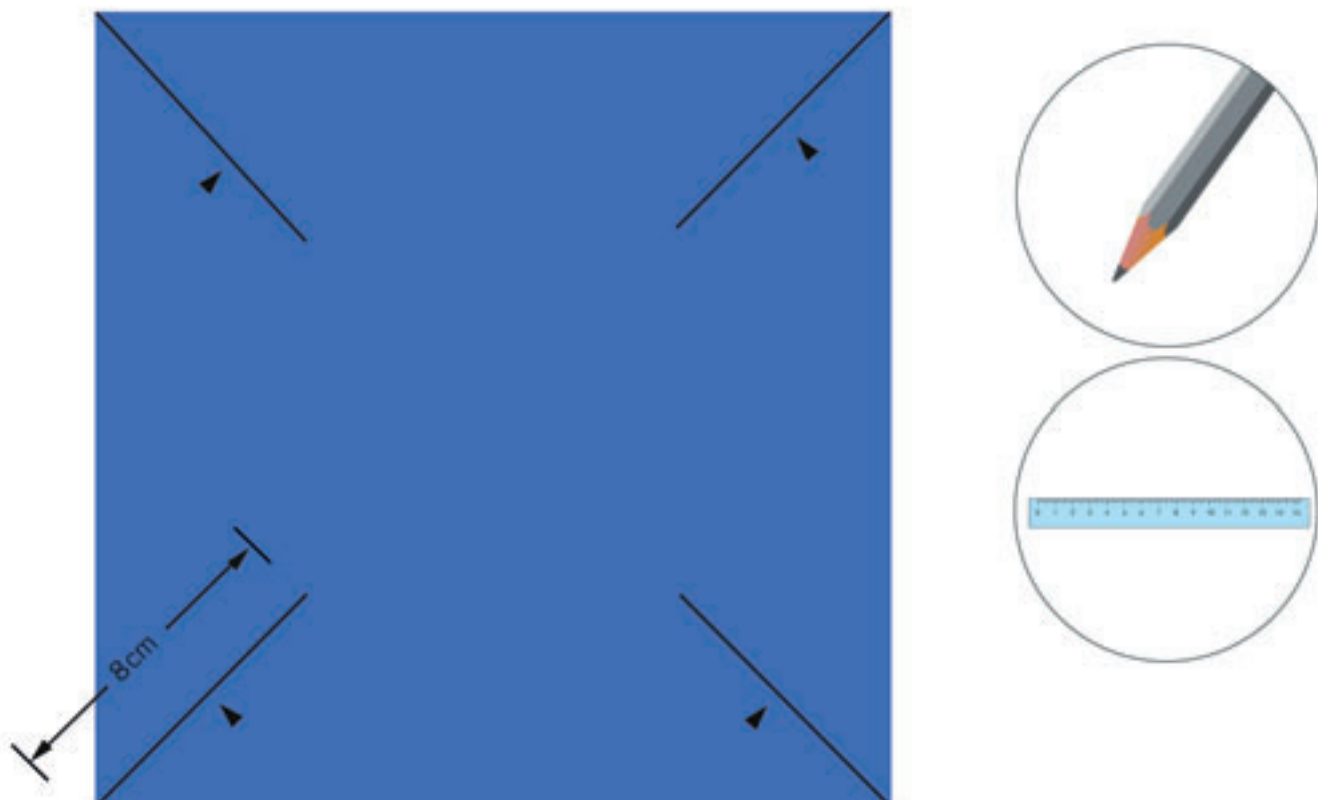

STEP 5

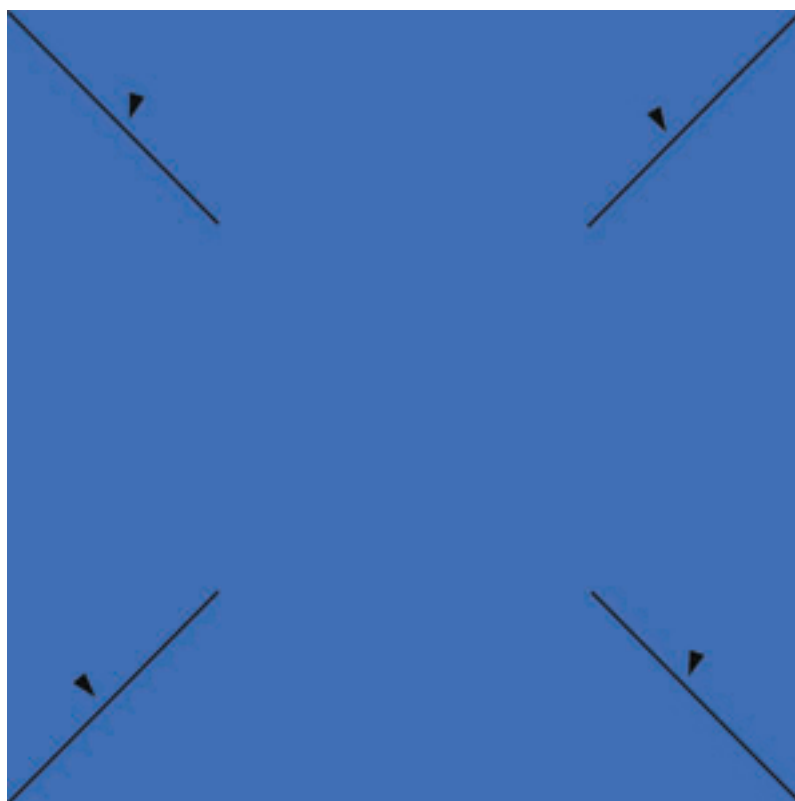

STEP 6

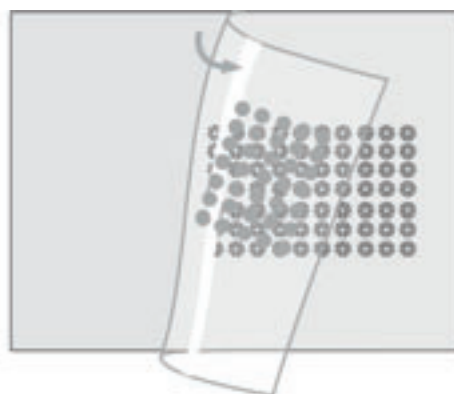
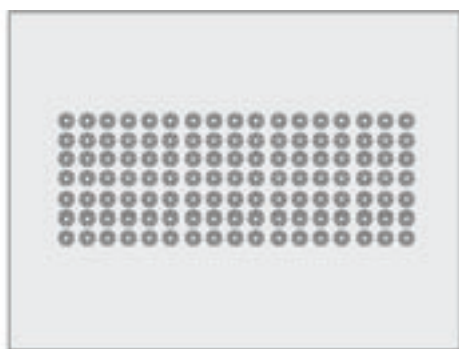

scale 1 : 1

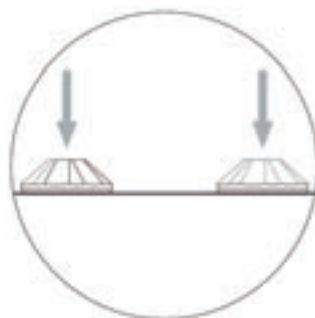
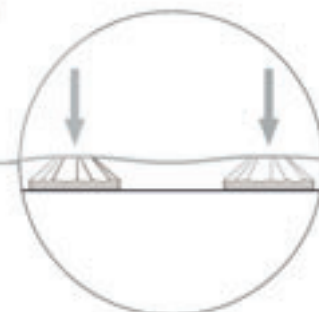
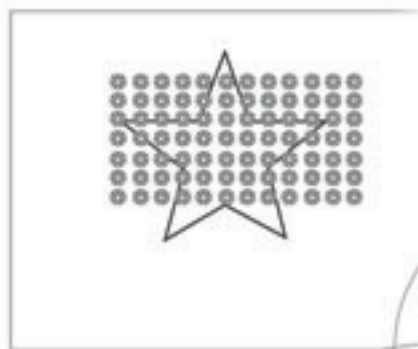

repeat step 6 x 11

STEP 7

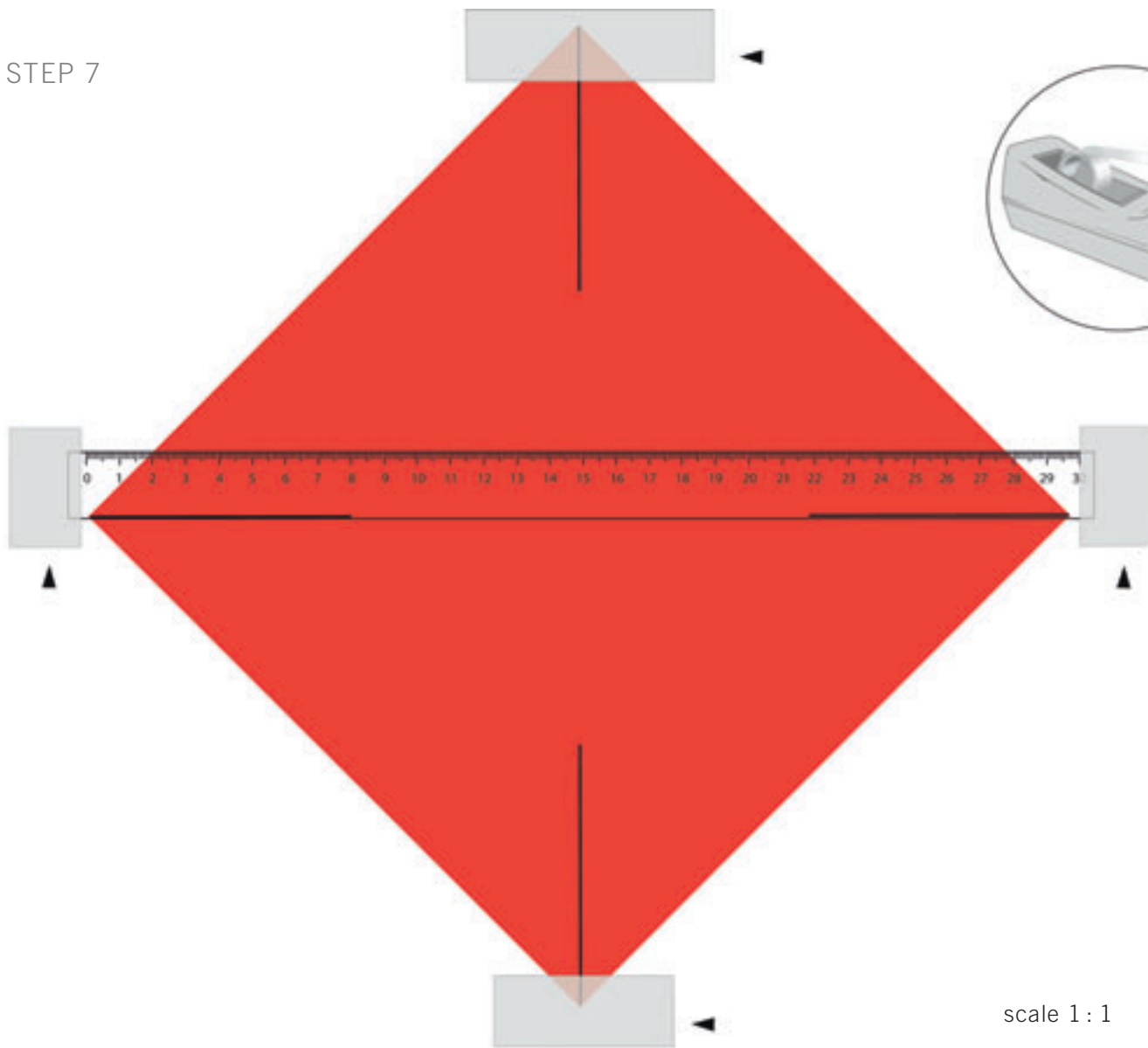

scale 1 : 1

STEP 8  
repeat step 6:

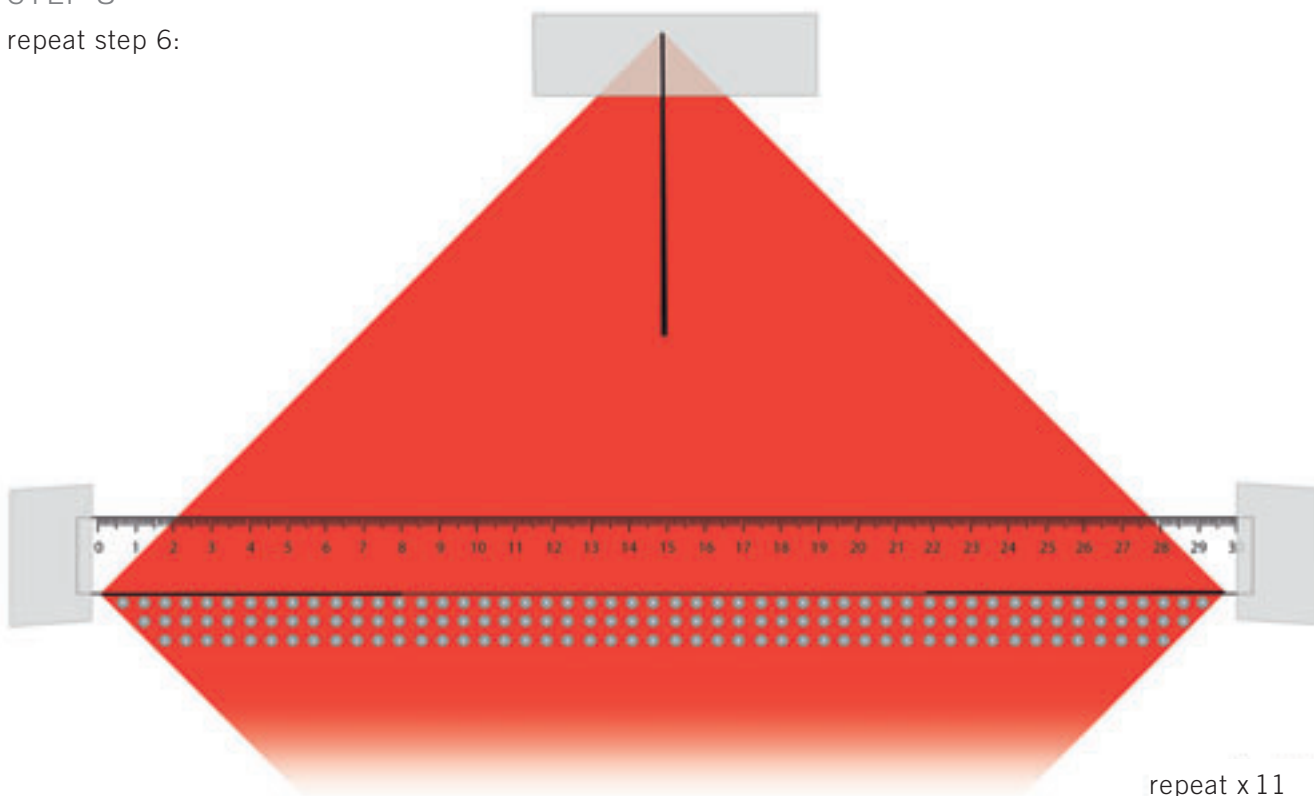

repeat x 11

STEP 9

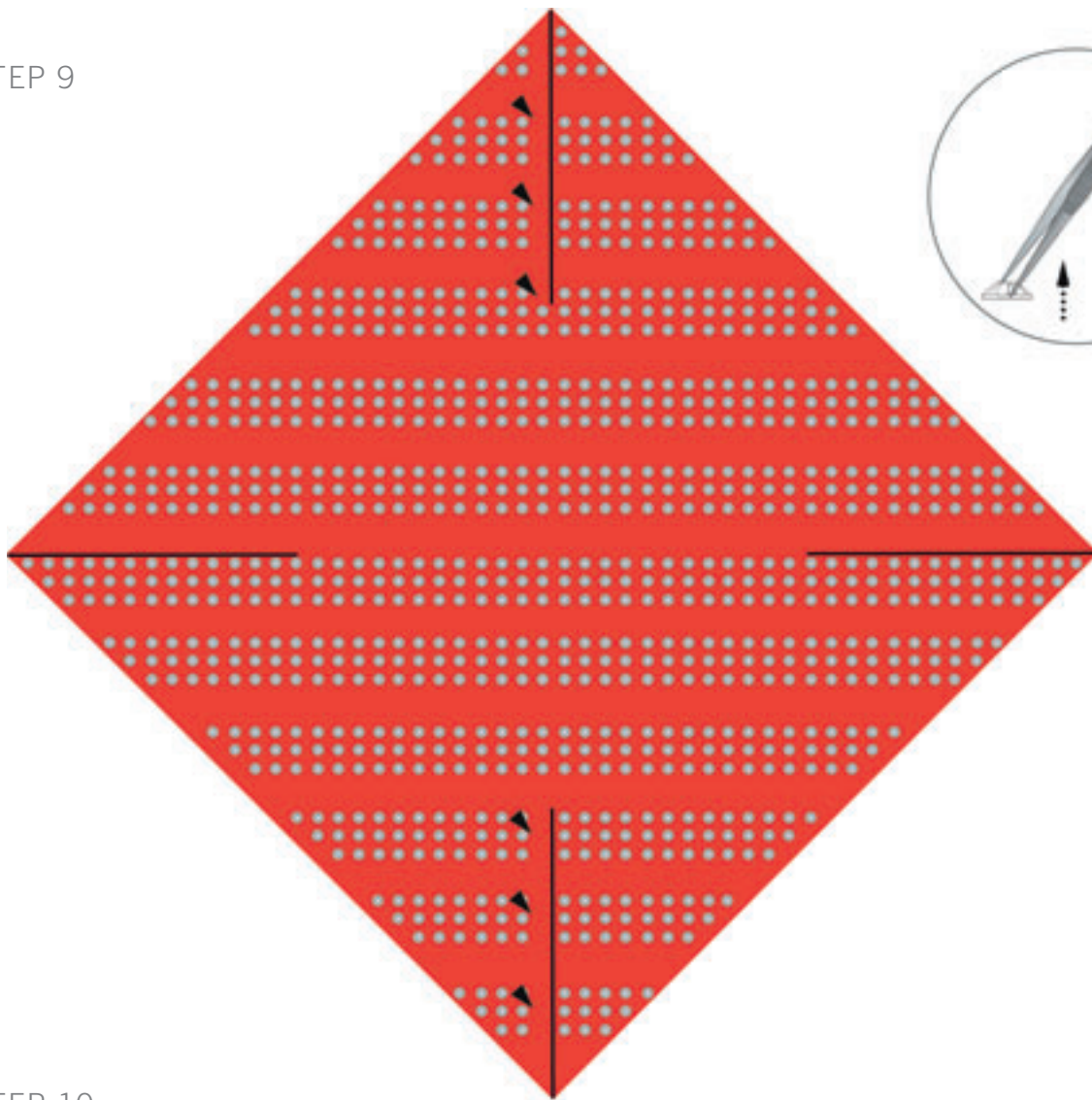

STEP 10

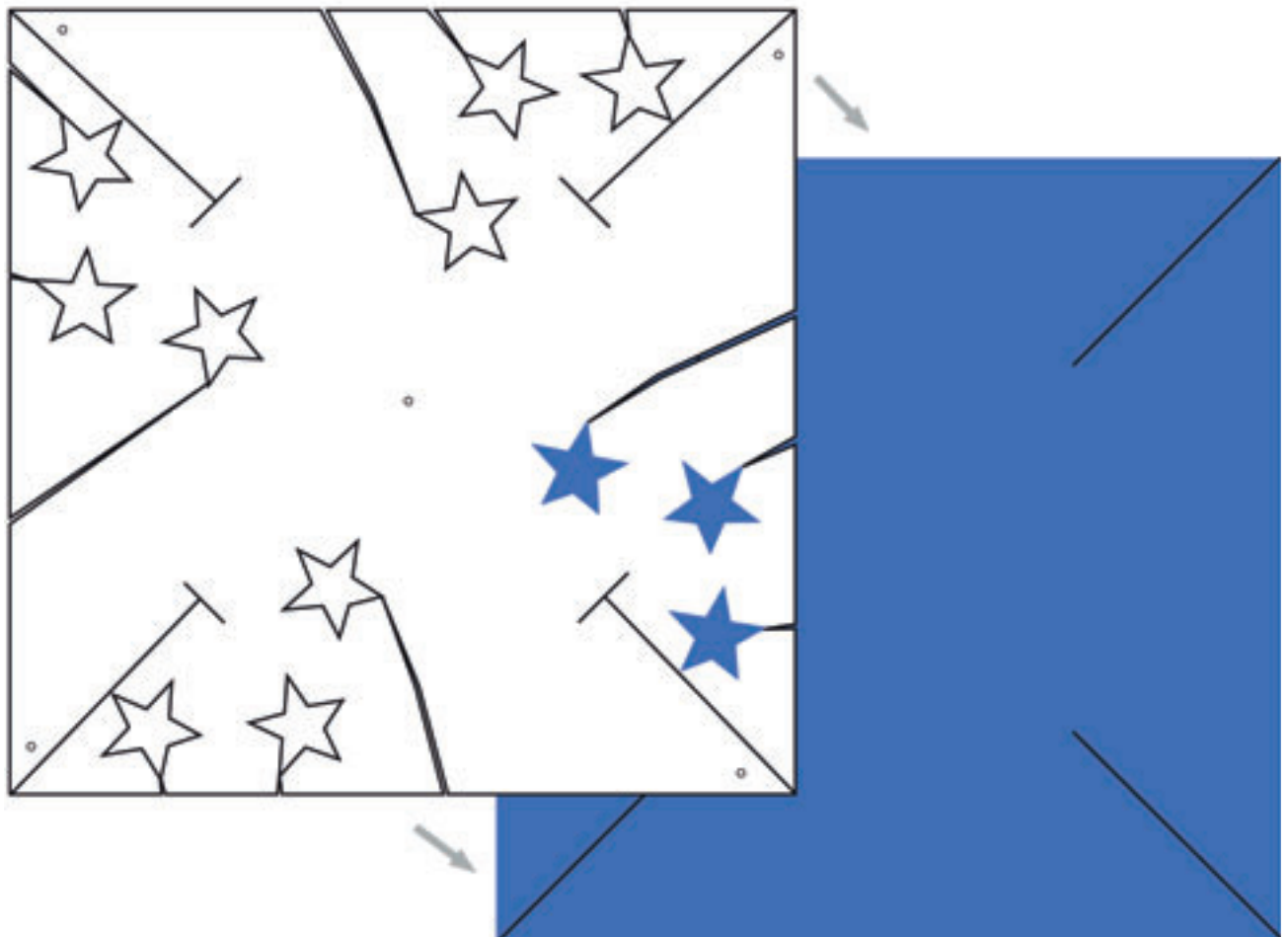



STEP 11

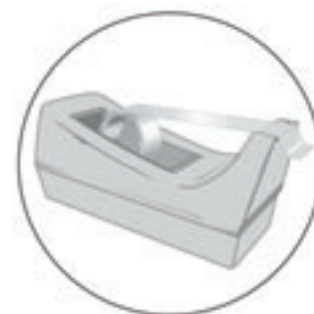
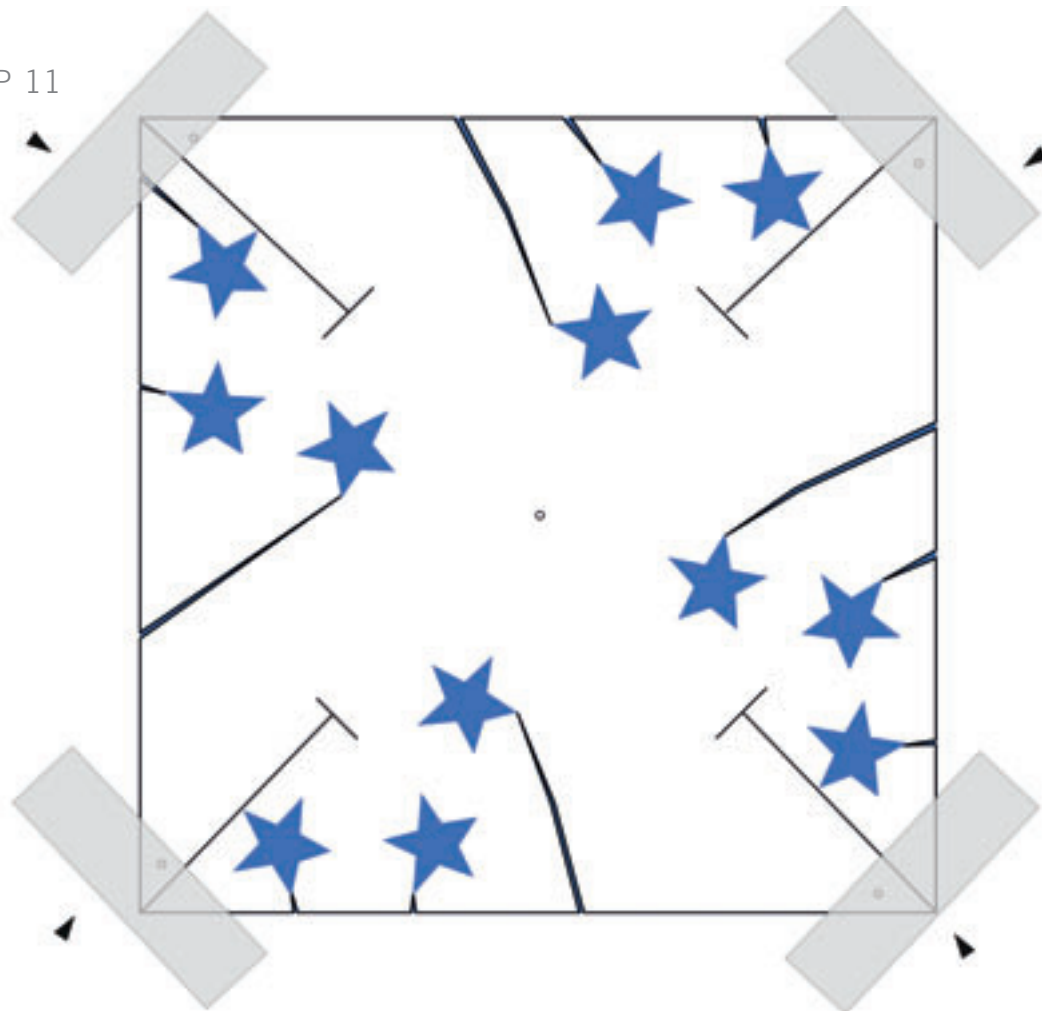

STEP 12

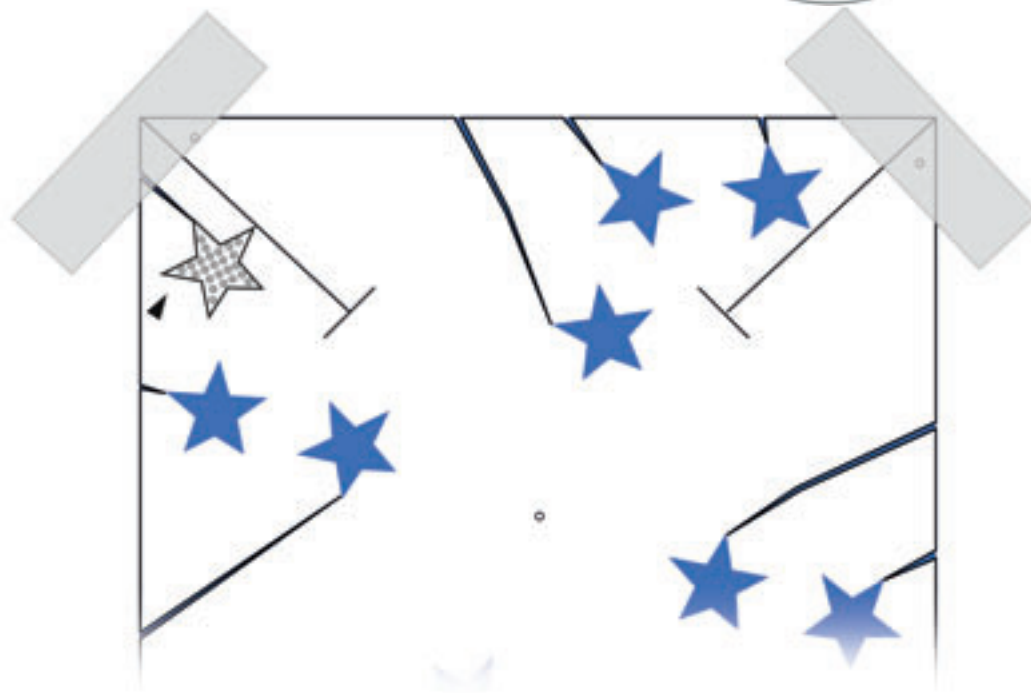

repeat x 11

STEP 13

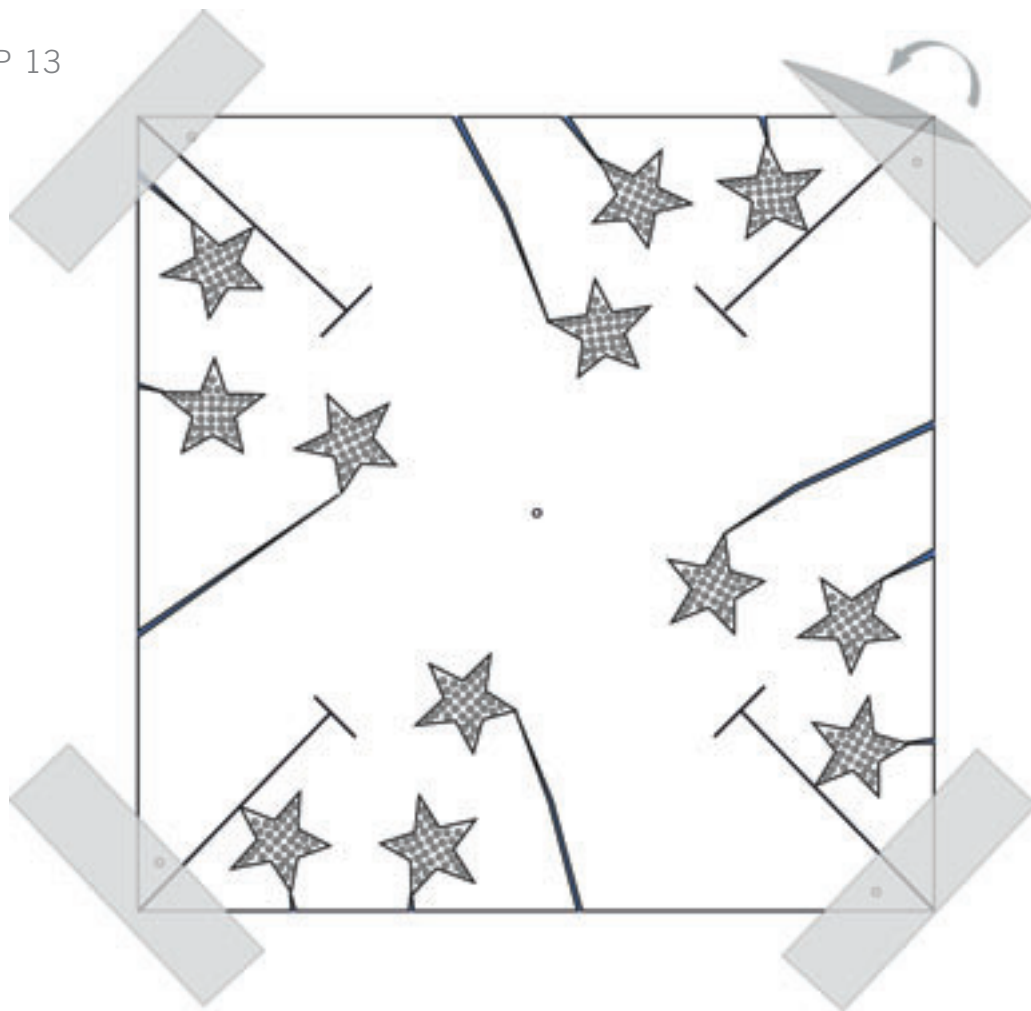

STEP 14

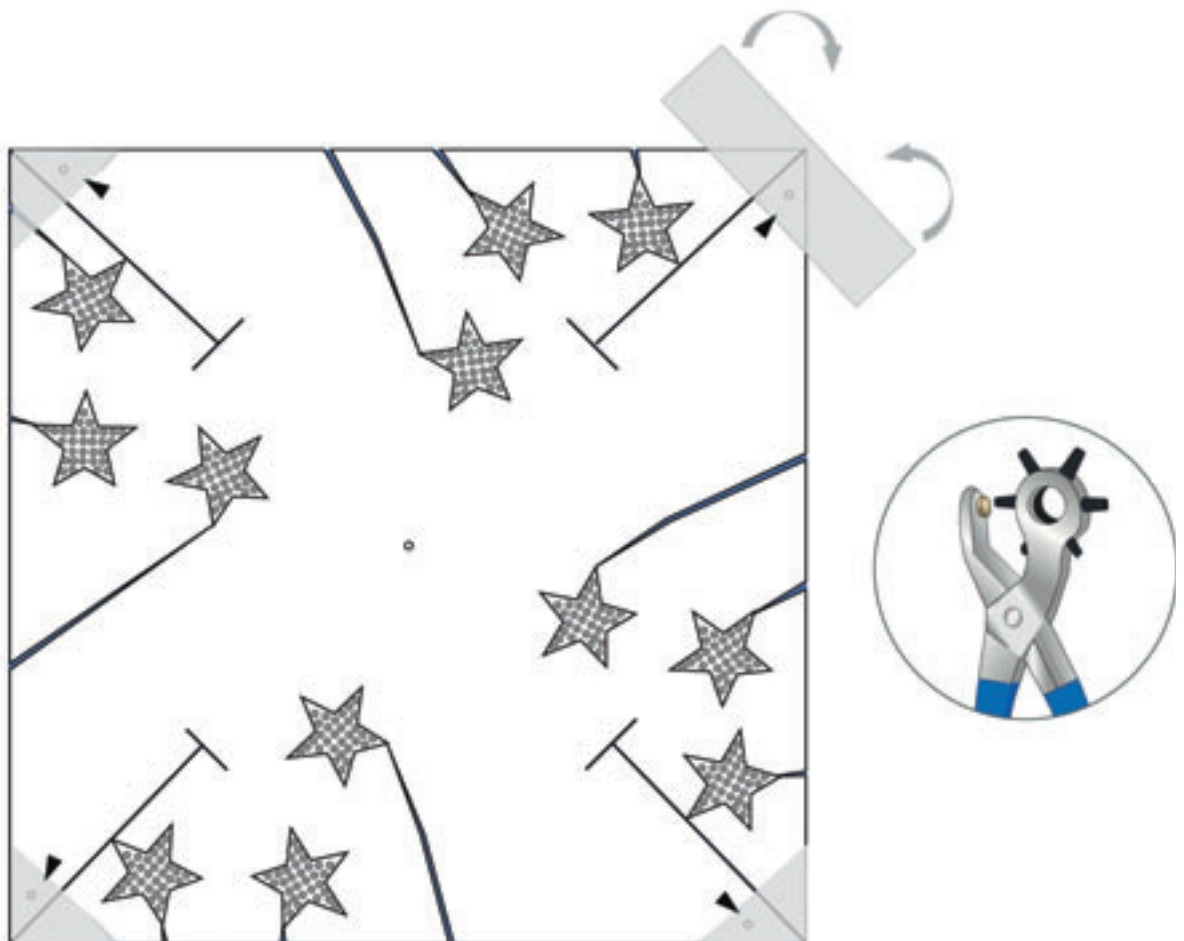

STEP 15

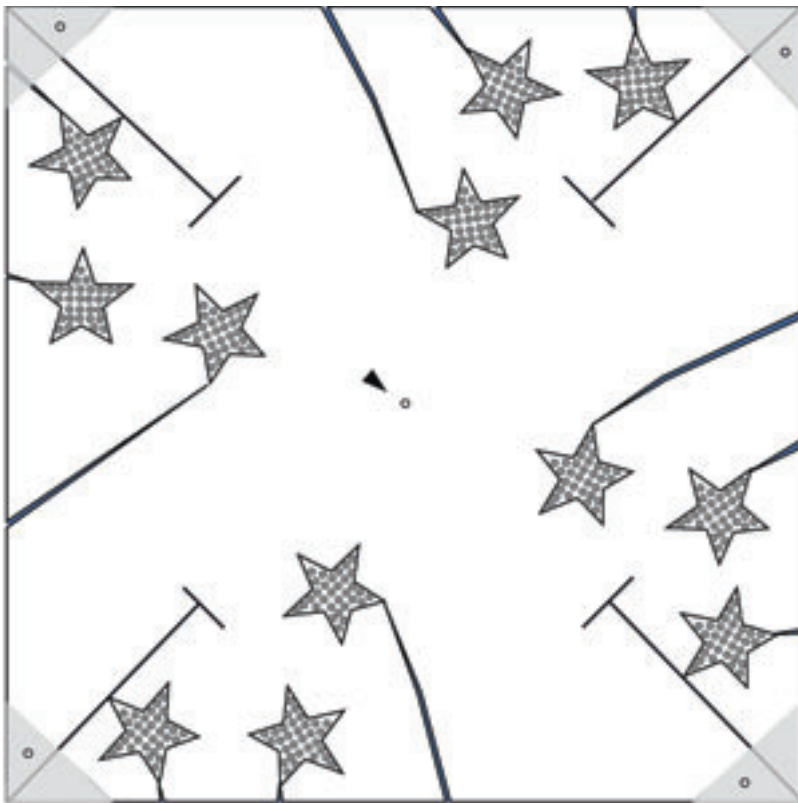

STEP 16

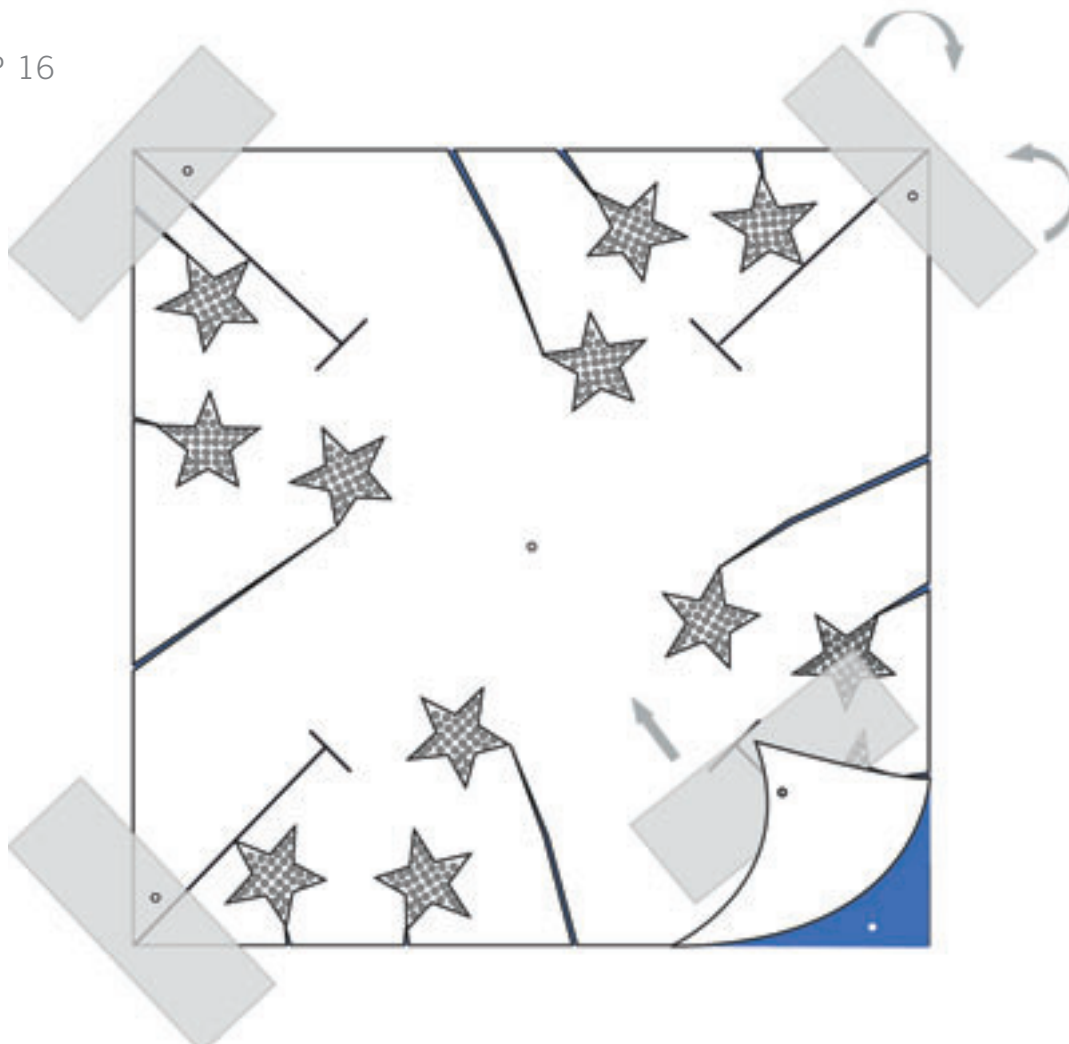

STEP 17

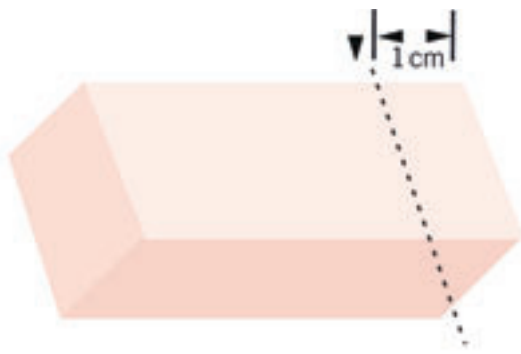

scale 1 : 1

STEP 18

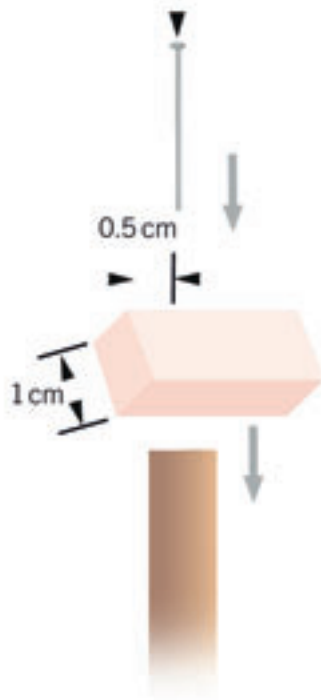

STEP 19

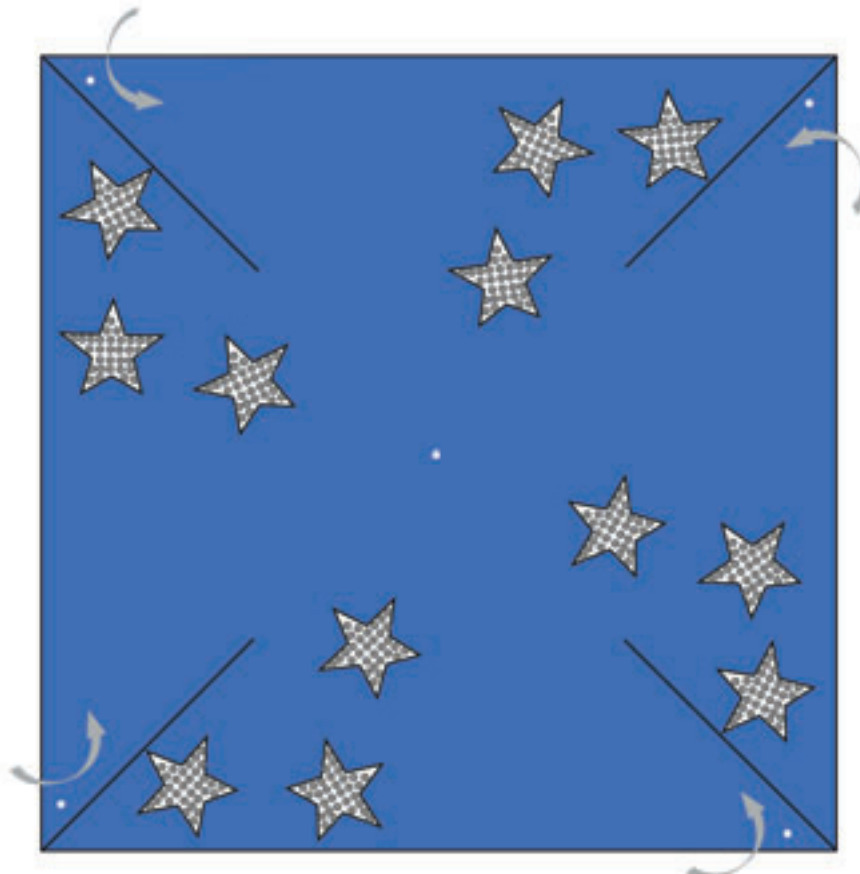

scale 1 : 2

STEP 20

1:1:

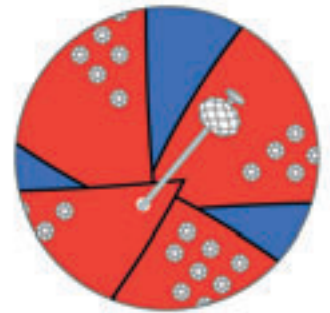
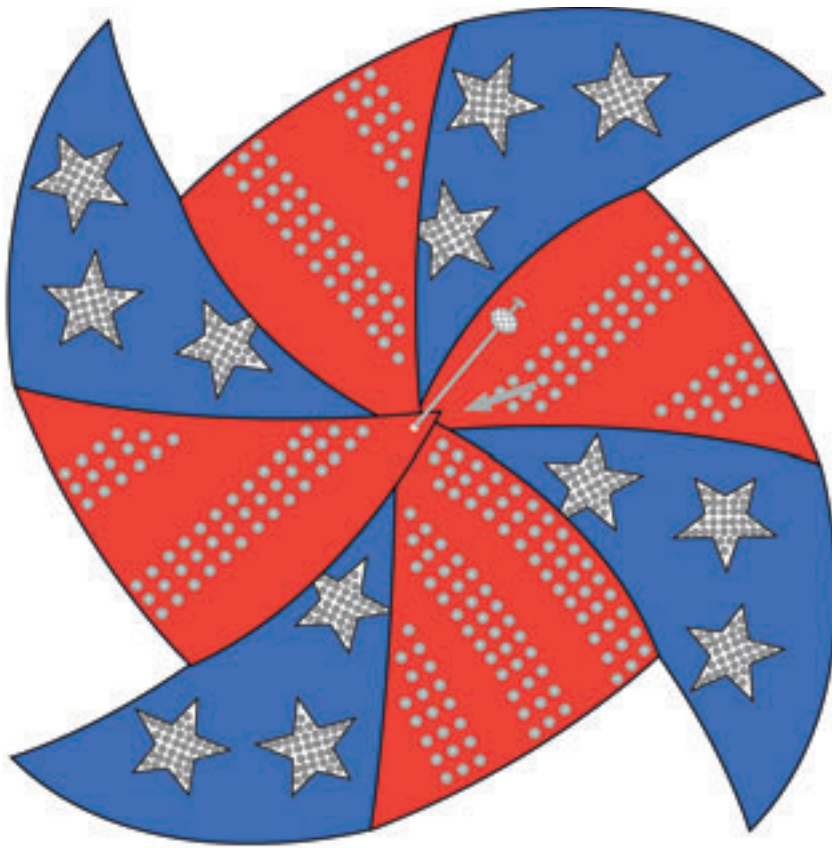

scale 1 : 2

STEP 21

1:1:

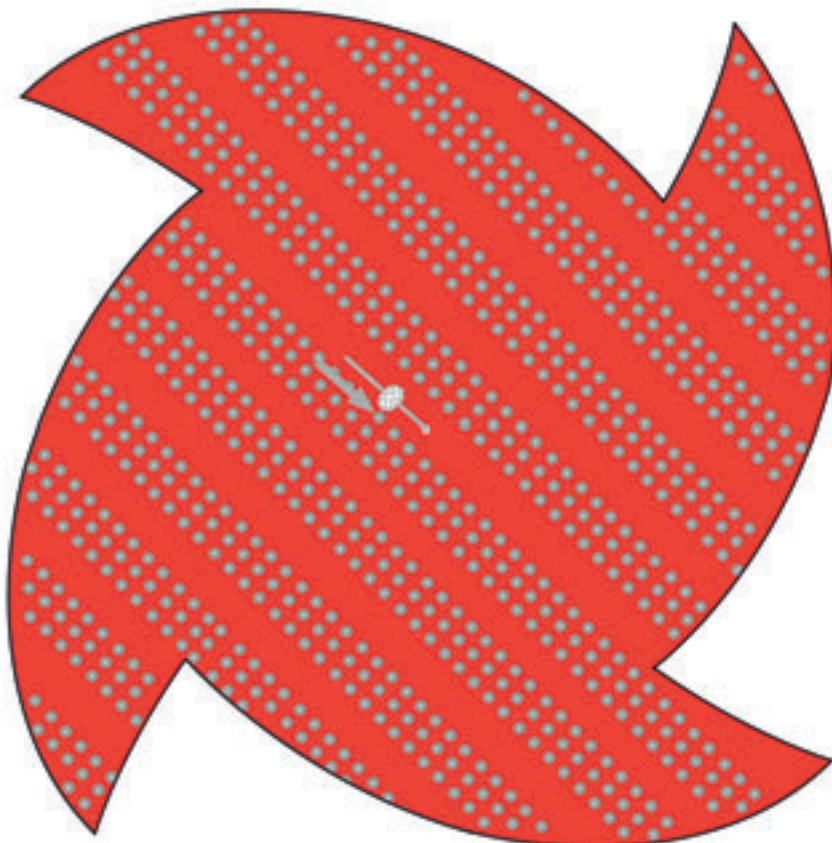

scale 1 : 2

STEP 22

